

Constant Voltage LED Driver

Model No.: PBL-60-12, PBL-60-24

Features

- 100-240VAC Input
- 1 channel constant voltage output, Max. total output power 60W
- Ultra-thin design, light weight and high efficiency
- Over-load / Short circuit protection
- Suitable for indoor LED lighting application
- 5 Year, 50,000hr warranty

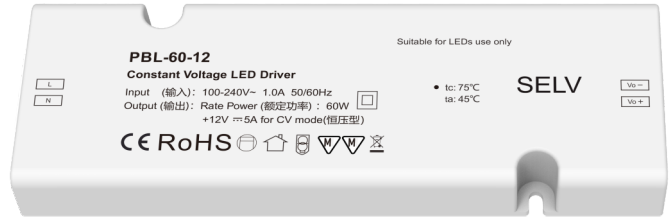

Applications

- Suitable for cabinet LED strip.

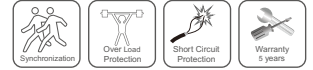

Technical Parameters

| Model | | PBL-60-12 | PBL-60-24 |
|-------------|---|--|-----------|
| Output | Output Voltage | 12VDC | 24VDC |
| | Output Current | Max. 5.0A | Max. 2.5A |
| | Output Power | Max. 60W | |
| | Startup time | 1S/230VAC, 2S/115VAC | |
| | Dimming Range | 0~100% | |
| | Ripple & Noise | 600mVp-p | |
| Input | Input Voltage Range | 100~240VAC | |
| | Frequency Range | 50/60Hz | |
| | Efficiency | 88% | |
| | Alternating Current | 1.0A/100VAC, 0.5A/230VAC | |
| | Power Factor | 0.5 | |
| | No Load Power | 0.3W | |
| | Inrush Current | Cold start 38A | |
| | Anti Surge | L-N:1KV | |
| Protection | Leakage Current | <0.75mA | |
| | Over Load | Shut down the output Voltage, when the load>=110%~140%, auto recovers. | |
| Environment | Short Circuit | Shut down the output Voltage, auto recovers | |
| | Working Temperature | -20°C~45°C | |
| | Tcase Max | 75°C | |
| | Working Humidity | 20%~90%RH, non-condensing | |
| | Storage Temperature/Humidity | -40°C~80°C, 10%~95%RH | |
| | Temperature Coefficient | ±0.03%/°C (0-50%) | |
| | Vibration Resistance | 10-500Hz, 2G, 6min/cycle, X,Y,Z axes/2min | |
| Safety&EMC | IP Rating | IP20 | |
| | Security Specifications | IEC/EN61347-1, IEC/EN61347-2-13, GB19510.14 | |
| | Withstand Voltage | I/P/O/P: 3750VAC | |
| | Insulation Resistance | I/P/O/P: 100MΩ/500VDC/25°C/70%RH | |
| | EMC Emission | EN61000-3-2 Class C, IEC61000-3-3 | |
| | EMC Immunity | EN61000-4-2,3.4.5.6.8.11, EN61547 | |
| Others | Certifications | CE | |
| | Net weight | 150g | |
| | Gross weight | 170g | |
| NOTE | Size | 164x55x18mm | |
| | All parameters NOT specially mentioned are measured at 230VAC input, rate current and 25 °C of ambient temperature. | | |

Mechanical Structures and Installations

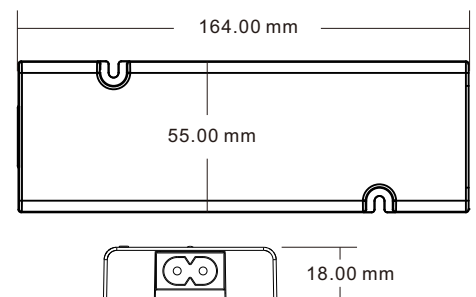
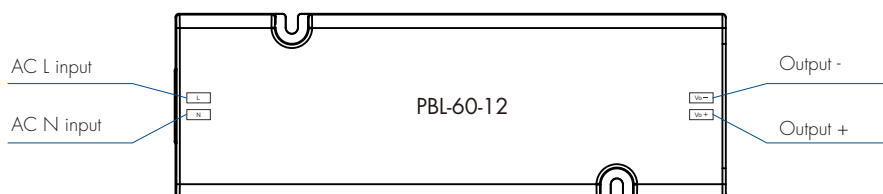

Wiring Diagram

1. Without dimming

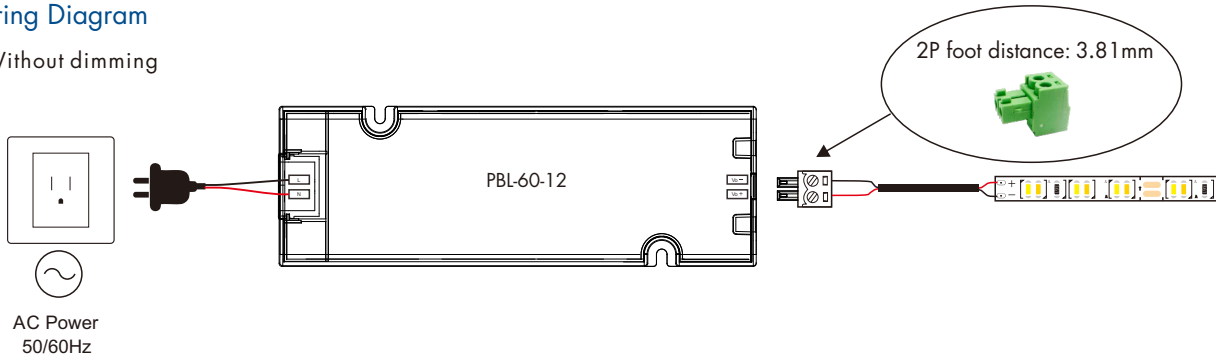

2. With dimming

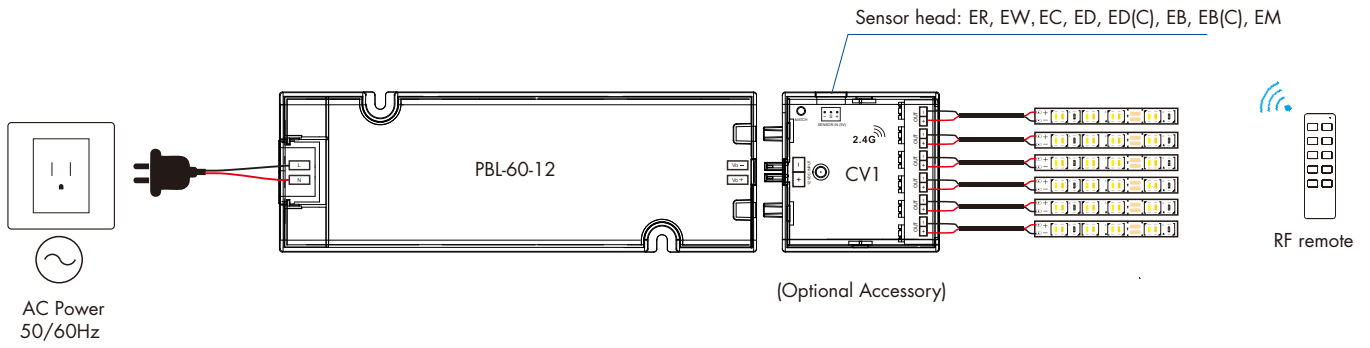

Output Load VS Temperature

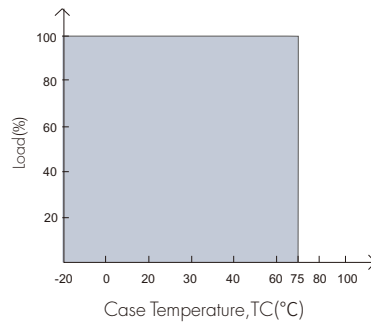
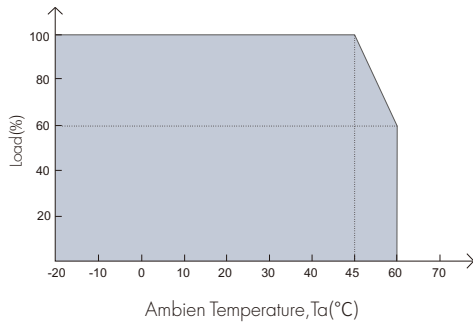

Static characteristic

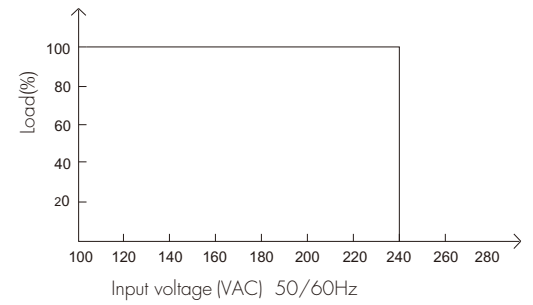

Installation precautions

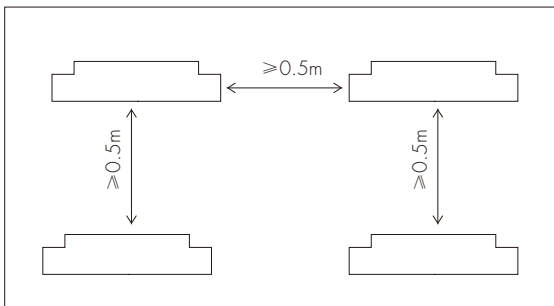

Please do not stack the products.

The distance between two products should be $\geq 0.5m$, so as not to affect heat dissipation and lifespan of the products.

Packing List



LED Driver
1 pcs



User Manual
1 pcs



2P Terminal
1 pcs



Accessories
(screw 2 pcs)



Slotted
screwdriver
1 pcs



Power supply cable
(Line length 1.5 meters)
1 pcs