

WiFi & RF to DALI Converter

Model No.:DA-M(WT)

6 in 1 / Tuya APP cloud control / Wireless remote control / Powered 24VDC / Encoding switch select address

Features

- WiFi & RF DALI master, 6 in 1 function, support single color, color temperature, RGB, RGBW, RGB+CCT, or switch light control.
- Tuya APP cloud control, support on/off, color temperature and brightness adjust, delay turn on/off light, timer run, scene edit and music play function.
- Match with RF 2.4G single zone or multiple zone remote control optional.
- 1 DALI address, support DT6 dimming, DT8-TC color temperature, DT8-RGB, DT8-RGBW or DT7 switch.
- In accordance with DALI standard protocol IEC 62386-101, 102, 207, 208, 209 and in compliance with DALI products from other international incorporation.
- Enable to select DALI address by encoding switch, support unicast, group and broadcast mode.

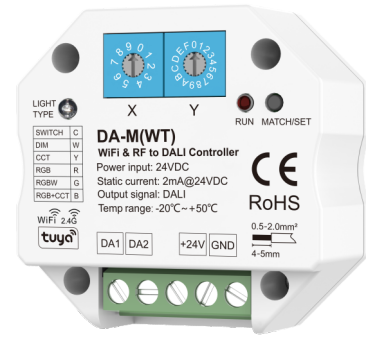

Technical Parameters

Input and Output		Environment		Package	
Power input	24VDC	Operation temperature	Ta: -20°C ~ +50°C	Size	W60 x L 60 x H40mm
Static current	2mA@24VDC	Case temperature (Max.)	Ta: +55°C	Gross weight	0.061kg
Input signal	Tuya APP + RF 2.4GHz	IP rating	IP20	Warranty	
Output signal	DALI			Warranty	5 years
Remote control distance	30m(open and barrier-free)				

Mechanical Structures and Installations

Rotary coding switch for setting DALI address

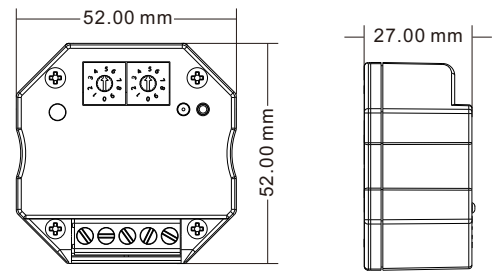
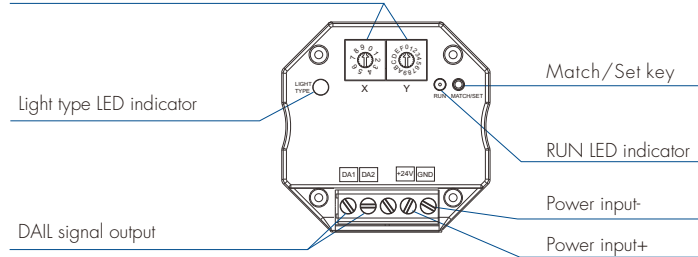

System wiring

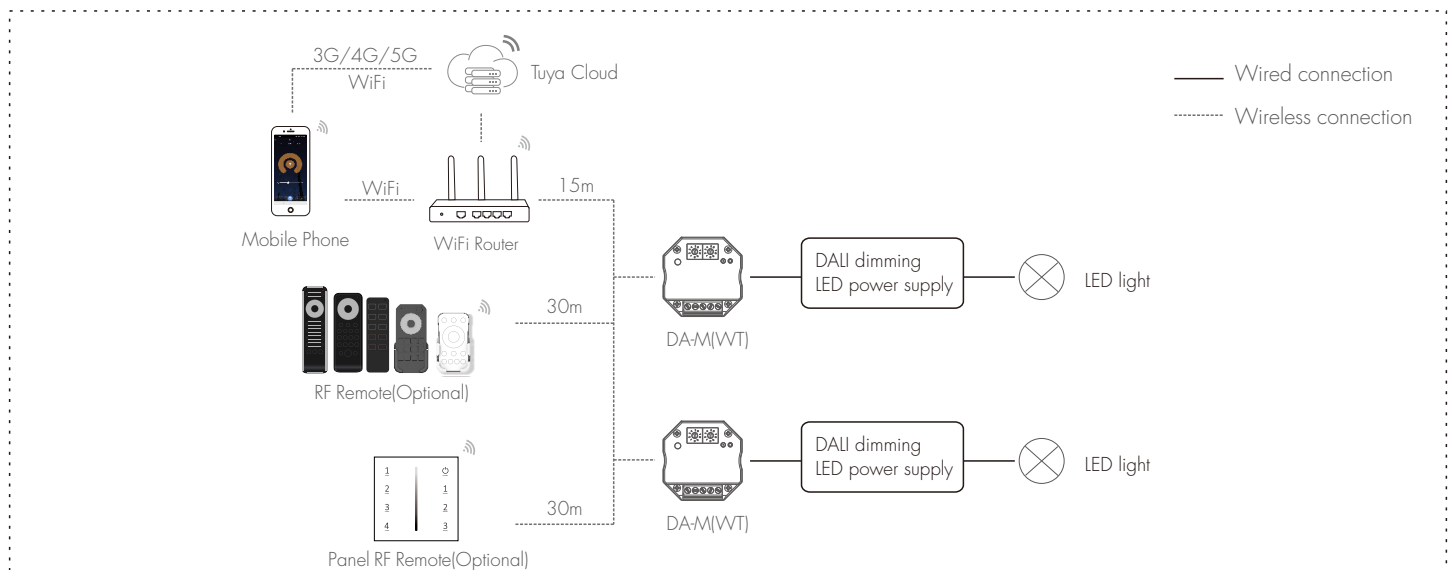

Note:

1. The above distance is measured in spacious(no obstacle) environment, Please refer to the actual test distance before installation.
2. Please check if the WiFi router net in 2.4G band, the 5G band is not available, and do not hide your router network.
3. Please keep the distance between DA-M(WT) devices and router close, and check the WiFi signals.
4. WiFi signal strength detection: open the main interface of the device, click to enter the device interface, and click "Check the device network" to detect.

Wiring Diagram

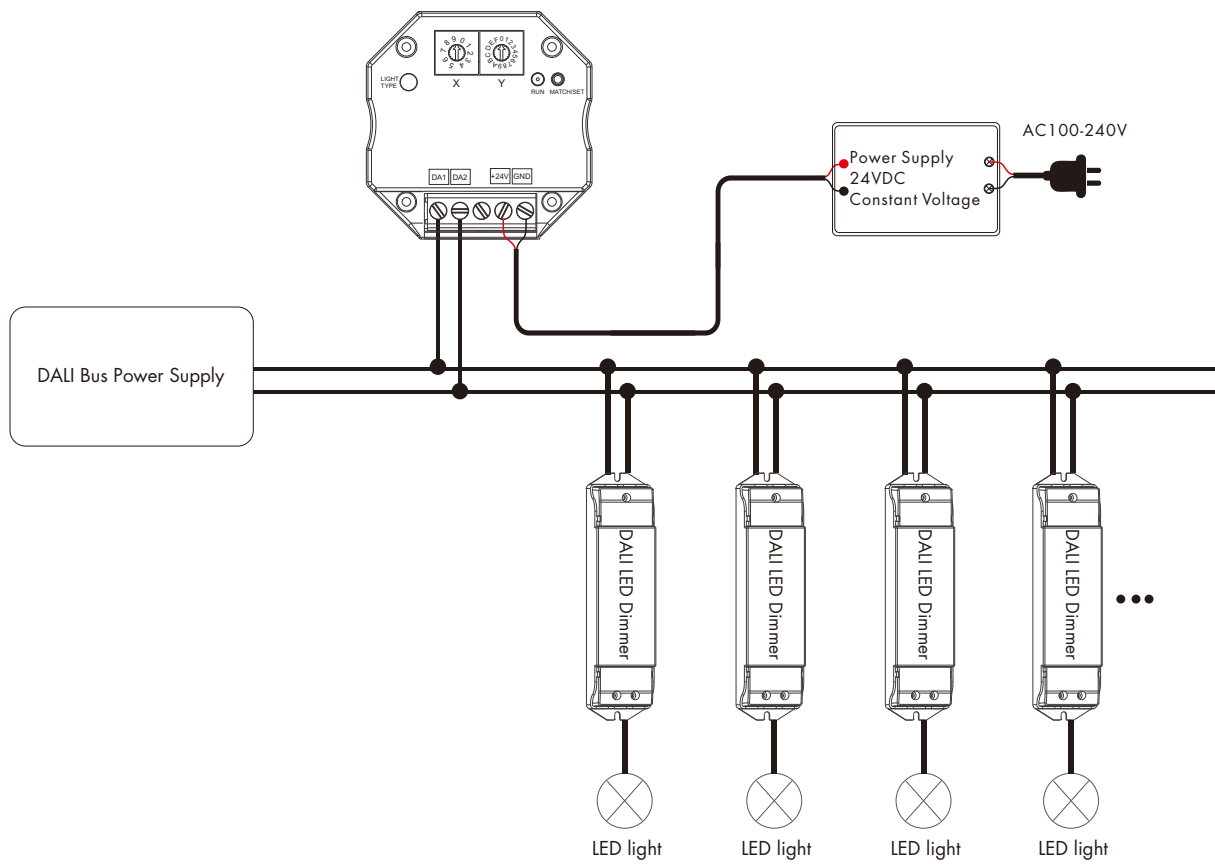

Note: When DA-M(WT) is working, because the power consumption of the WiFi module is too large, it cannot be powered by the DALI bus power supply.

Light type settings

SWITCH	C
DIM	W
CCT	Y
RGB	R
RGBW	G
RGB+CCT	B

Please select the light type before Tuya APP network connection config.

Press and hold Match/Set key for 2s, switch 6 kinds light type in sequence, and light type LED indicator turn corresponding color.

White: DIM

Yellow: CCT

Red: RGB

Green: RGBW

Blue: RGB+CCT

Cyan: SWITCH

Tuya APP network connection

Push twice Match/Set key fastly: Clear previous network connection, enter Smart config mode, the RUN LED indicator flash fastly.

Press and hold Match/Set key for 5s: Clear previous network connection, enter AP config mode, the RUN LED indicator flash slowly.

If smart config failed, please try AP config.

Repeat power on and off for 5 consecutive times, also clear previous network connection, the RUN LED indicator flash fastly.

If Tuya APP network connection succeed, the RUN LED indicator stops flash.

And in Tuya APP, you can find DIM device (or CCT, RGB, RGBW, RGB+CCT, SWITCH device).

Tuya APP interface

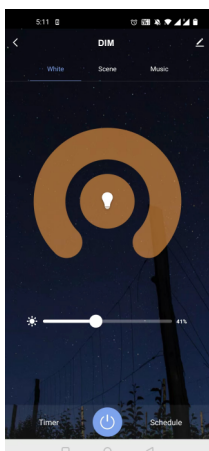

White interface

For DIM type:
Touch brightness slide to adjust brightness.

For RGB type:
Touch brightness slide,
get RGB mixed white firstly,
then to adjust white brightness.

For RGBW type:
Touch brightness slide,
adjust white channel brightness.

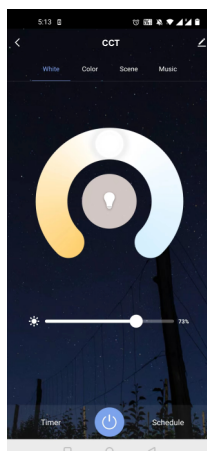

Color temperature interface

For CCT type:
Touch color wheel
to adjust color temperature.
Touch brightness slide
to adjust brightness.

For RGB+CCT type:
Touch color wheel to adjust color
temperature, RGB will turn off automatically.
Touch brightness slide to adjust white brightness.

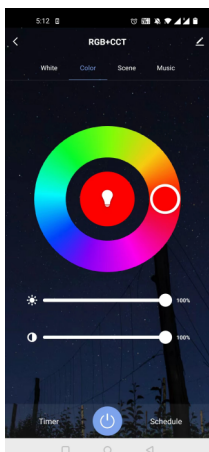

Colour interface

For RGB or RGBW type:
Touch color wheel to adjust static RGB color.
Touch brightness slide to adjust color brightness.
Touch saturation slide to adjust color saturation, namely gradient from the current color to white(RGB mixed).

For RGB+CCT type:
Touch color wheel to adjust static RGB color, CCT will turn off automatically.
Touch brightness slide to adjust color brightness.
Touch saturation slide to adjust color saturation, namely gradient from the current color to white (RGB mixed)

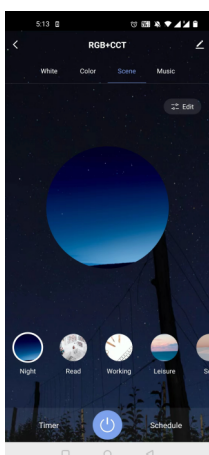

Scene interface

The 1-4 scene is static color for all light type.
the inner color of these scene can be editable.
The 5-8 scene is dynamic mode for RGB type,
such as green fade in and fade out, RGB jump,
6 color jump, 6 color smooth.

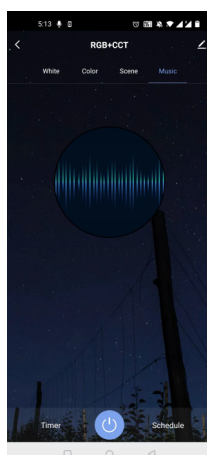

Music, Timer, Schedule

The music play can use smart phone music player
or micro-phone as music signal input.
The Timer key can turn on or turn off light in the next
24 hours.
The Schedule key can add multiple timers to turn on
or turn off light according to different time periods.

Match Remote Control (Optional)

Please select the same light type of RF remote control for matching,
End user can choose the suitable match/delete ways. Two options are offered for selection:

Use the Match key

Match:

Short press match key, immediately press on/off key (single zone remote) or zone key (multiple zone remote) on the remote.
The RUN LED indicator fast flash a few times means match is successful.

Delete:

Press and hold match key for 10s to delete all match,
The RUN LED indicator fast flash a few times means all matched remotes were deleted.

Use Power Restart

Match:

Switch off the power of the receiver, then switch on power, repeat again.
Immediately short press on/off key (single zone remote) or zone key (multiple zone remote) 3 times on the remote.
The RUN LED indicator blinks 3 times means match is successful.

Delete:

Switch off the power of the receiver, then switch on power, repeat again.
Immediately short press on/off key (single zone remote) or zone key (multiple zone remote) 5 times on the remote.
The RUN LED indicator blinks 5 times means all matched remotes were deleted.

DAI address setting

Address value = $X * 10 + Y$.

For example: $X = 5, Y = 4$, Address value = $5 * 10 + 4 = 54$.

Unicast mode

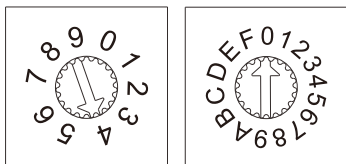

X

Y

X is 0-6, Y is 0-9.

Address value 0-63 correspond to DAI unicast address 00-63.

For example:

Address value = 40, the unicast address value is 40.

Group mode

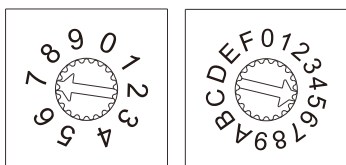

X

Y

X is 7, Y is 0-F.

Address value 70-7F correspond to DAI group address 0-15.

For example:

Address value = 75, the group address value is 5.

Broadcast mode

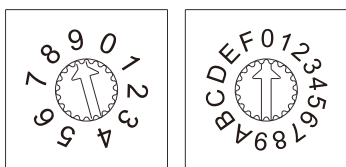

X

Y

X is 9, Y is 0-F.

Address value 90 - 9F correspond to broadcast address.