

# LT-122 2CH SPI Signal Amplifier



LT-122 SPI amplifier can realize SPI (TTL) signal's expansion, amplification and distribution. Especially suitable for multi-channel sync control projects. It can copy the changes of one channel LEDs to others, so you can connect dozens LEDs than before by install several signal amplifiers, and save lots of money on the project.

LT-122 SPI signal amplifier is full compatibility. can be used to expand all manufacturers' SPI(TTL) signal controller and lamp's signal in market. And It can connect with SPI(TTL) signal of all ICs .

## 1. Parameter:

LT-122	
Input Voltage:	5~36Vdc
Input Signal:	1CH SPI(TTL)
Output Signal:	2CH SPI(TTL)
Waterproof Level:	IP66
Working Temp.	-25°C~50°C
Dimension	L92×W37×H30mm
Package Size	L123×W43×H42mm
Weight(G.W.)	110g

## 2. Product Size:



1

## 3. Wiring Diagram:

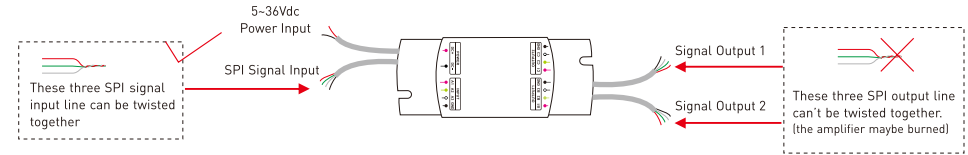

3.1 LED strip signal expansion of WS2811 single wire.

3.2 LED strip signal expansion of WS2801 double wire.

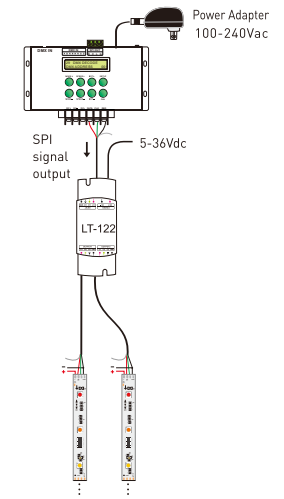
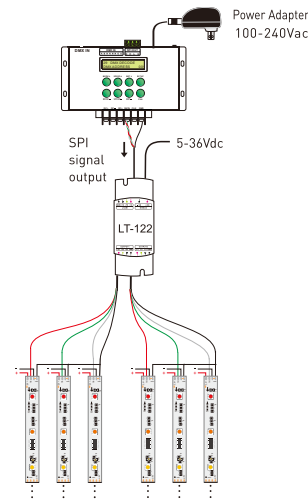

3.3 Multiple pixel screen synchronous display.

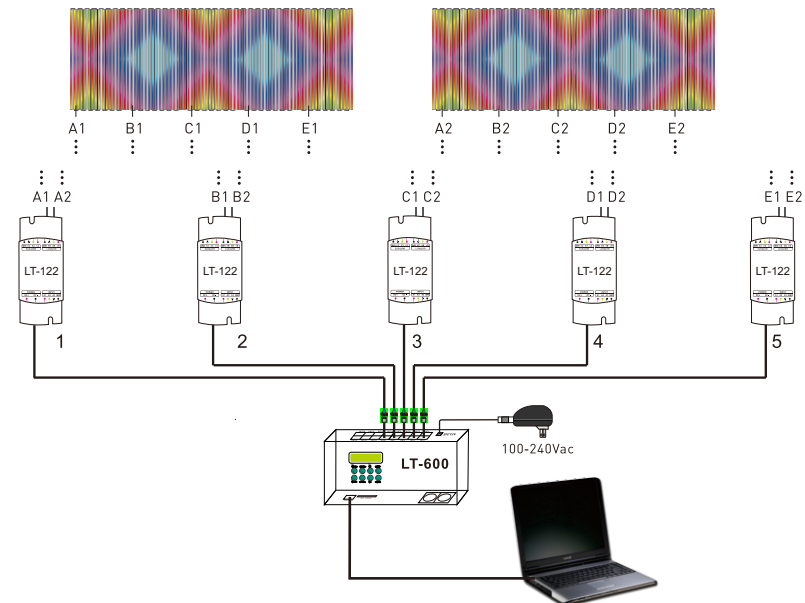

2

3.4 Distance display:

A. Signal wire extending between controller and LED lamps.

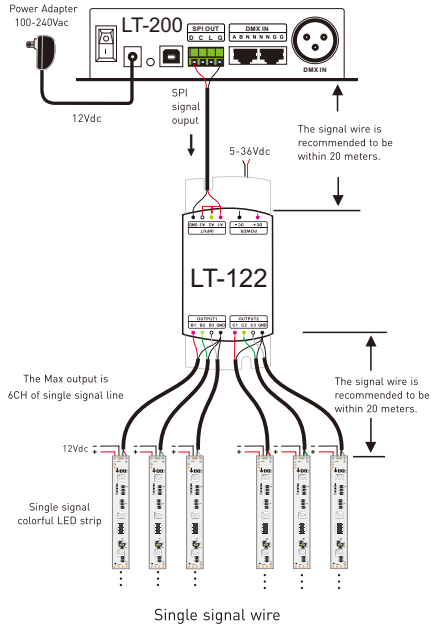

B. Signal wire extending between LED lamps.

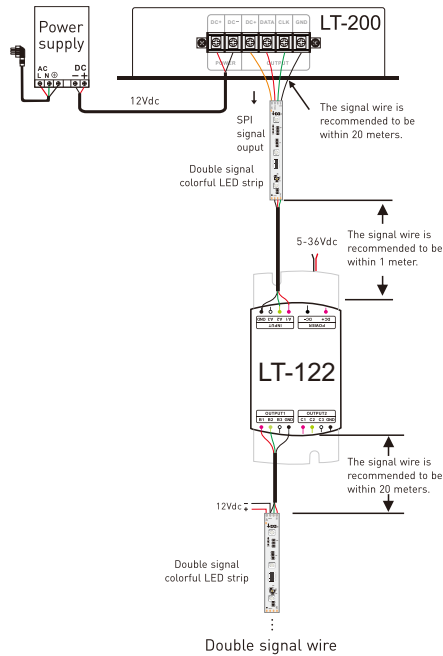
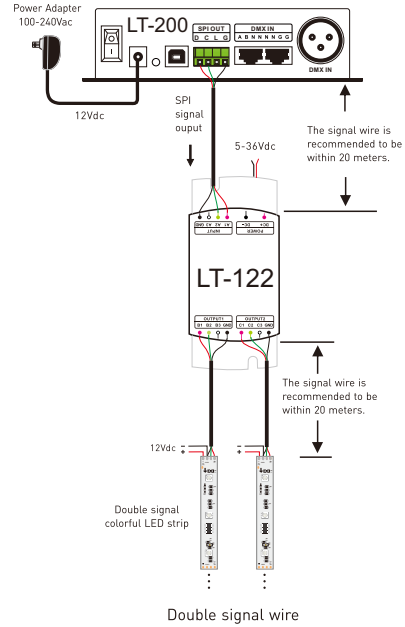
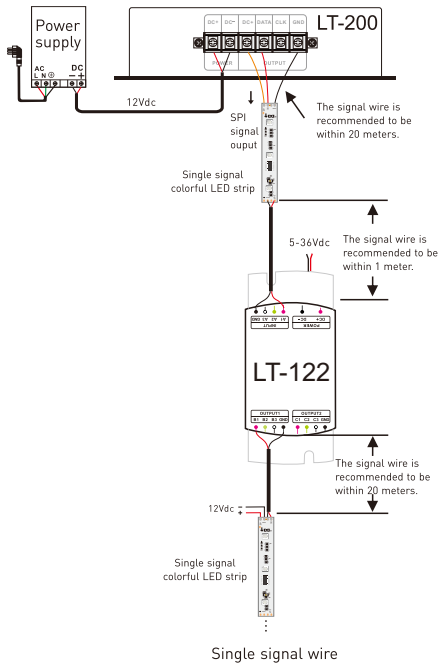

C. Several piece relay extending

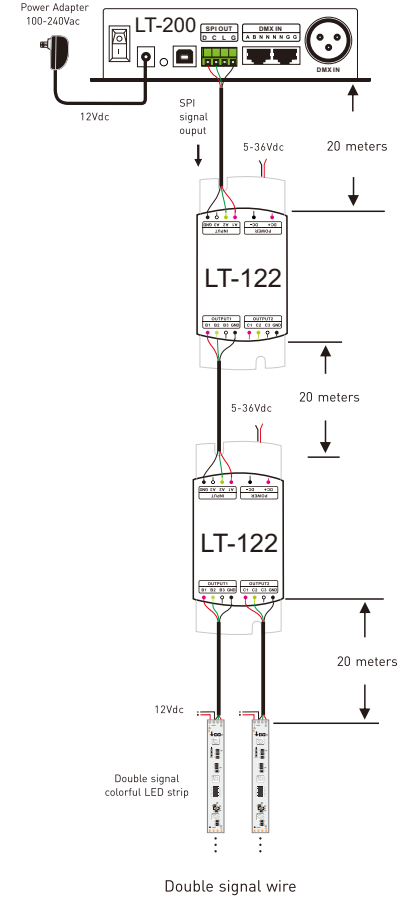
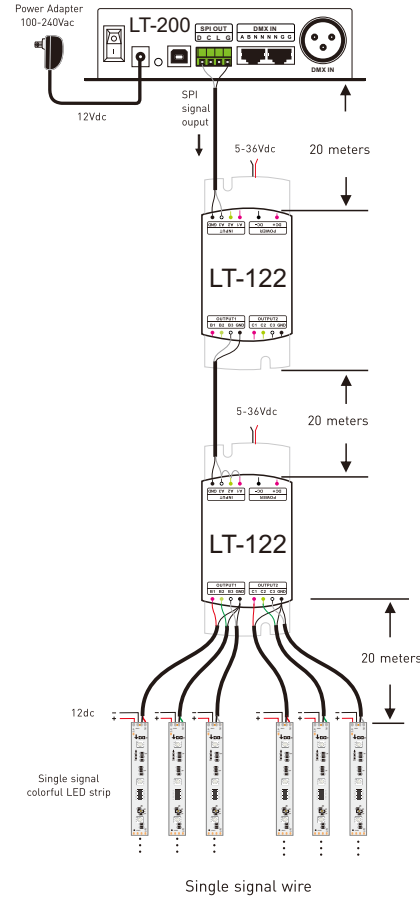

\* No further notice if any changes in the manual.  
Product function depends on the goods.  
Please feel free to contact our official distributor if any question.